

# Flat

Design by Ichiro Iwasaki

Flat's distinctive, disc-shaped diffusers form horizontal planes of light that integrate with the surrounding architecture. A study in geometry, the collection creates layers of light that infuse a space with a soothing, Zen sensitivity.

---

## Ceiling



ø 40 cm

**5920**



ø 55 cm

**5915**



ø 90 cm

**5926**



101 x 88 cm

**5905**



106 x 90 cm

**5910**



178 x 149 cm

**5922**



186 x 149 cm

**5924**

5905

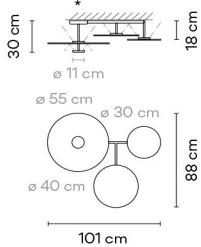

<b>Finishes</b>	<b>LED temperature colour</b>	<b>Control</b>
<ul style="list-style-type: none"> <li>● <b>10/</b> __ White (NCS S 0300-N)</li> <li>● <b>71/</b> __ White, Green L1, Grey L1 (NCS S 0300-N, NCS S 4005-G80Y, NCS S 1000-N)</li> </ul>	<ul style="list-style-type: none"> <li><b>/1</b> _ 2700 K <b>E</b> CRI &gt;90 5906,88 lm 109 lm/W</li> <li><b>/3</b> _ 3500 K <b>F</b> CRI &gt;90 6344,4 lm 117,5 lm/W</li> </ul>	<b>5905</b> __ / _ A DALI-2, 1-10V, Push

<b>Materials</b>	<b>Packaging</b>
Shade: Aluminum. Diffuser: Polycarbonate. Structures: Steel. Canopy: Aluminum.	1 Box 0,75 x 0,45 x 0,25 m Vol 0,0844 m <sup>3</sup> Gross weight 17,15 Kg Net weight 15,38 Kg
<b>Light Source and electronics</b>	<b>Notes</b>
4 x LED PLATE 13,5 W 700 mA Constant Current 700 mA 110-240V 50/60Hz	* Electrical connection point
	<div style="display: flex; gap: 5px;"> <span>LED</span> <span>IP20</span> <span>CE</span> <span>Dimmer</span> </div>

5910

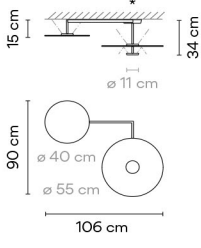

<b>Finishes</b>	<b>LED temperature colour</b>	<b>Control</b>
<ul style="list-style-type: none"> <li>● <b>10/</b> __ White (NCS S 0300-N)</li> <li>● <b>72/</b> __ White, Green L1 (NCS S 0300-N, NCS S 4005-G80Y)</li> <li>● <b>73/</b> __ White, Grey L1 (S 0300-N, NCS S 1000-N)</li> </ul>	<ul style="list-style-type: none"> <li><b>/1</b> _ 2700 K <b>E</b> CRI &gt;90 4430,16 lm 109 lm/W</li> <li><b>/3</b> _ 3500 K <b>F</b> CRI &gt;90 4758,3 lm 117,5 lm/W</li> </ul>	<b>5910</b> __ / _ A DALI-2, 1-10V, Push

<b>Materials</b>	<b>Packaging</b>
Shade: Aluminum. Diffuser: Polycarbonate. Structures: Steel. Canopy: Aluminum.	1 Box 0,80 x 0,70 x 0,30 m Vol 0,1680 m <sup>3</sup> Gross weight 11,90 Kg Net weight 9,10 Kg
<b>Light Source and electronics</b>	<b>Notes</b>
3 x LED PLATE 13,5 W 700 mA Constant Current 700 mA 110-240V 50/60Hz	* Electrical connection point
	<div style="display: flex; gap: 5px;"> <span>LED</span> <span>IP20</span> <span>CE</span> <span>Dimmer</span> </div>

5915

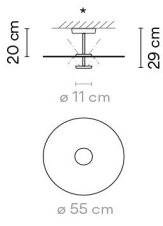

<b>Finishes</b>	<b>LED temperature colour</b>	<b>Control</b>
<ul style="list-style-type: none"> <li>● <b>10/</b> __ White (NCS S 0300-N)</li> </ul>	<ul style="list-style-type: none"> <li><b>/1</b> _ 2700 K <b>E</b> CRI &gt;90 2953,44 lm 109 lm/W</li> <li><b>/3</b> _ 3500 K <b>F</b> CRI &gt;90 3172,2 lm 117,5 lm/W</li> </ul>	<b>5915</b> __ / _ A DALI-2, 1-10V, Push

<b>Materials</b>	<b>Packaging</b>
Shade: Aluminum. Diffuser: Polycarbonate. Structures: Steel. Canopy: Aluminum.	1 Box 0,65 x 0,65 x 0,25 m Vol 0,0106 m <sup>3</sup> Gross weight 6,80 Kg Net weight 4,73 Kg
<b>Light Source and electronics</b>	<b>Notes</b>
2 x LED PLATE 13,5 W 700 mA Constant Current 700 mA 110-240V 50/60Hz	* Electrical connection point
	<div style="display: flex; gap: 5px;"> <span>LED</span> <span>IP20</span> <span>CE</span> <span>Dimmer</span> <span>Bi-volt</span> </div>

# Flat

5920

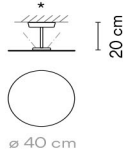

- Finishes**
- 10/ \_\_ White (NCS S 0300-N)
  - 13/ \_\_ Off-White (NCS S 1000-N)
  - 47/ \_\_ Green L1 (NCS S 4005-G80Y)

- LED temperature colour**
- /1 \_ 2700 K CRI >90 1740 lm 129 lm/W
  - /3 \_ 3500 K CRI >90 1868,9 lm 138,4 lm/W

- Control**
- 5920 \_\_ / \_ 1 DALI-2
  - 5920 \_\_ / \_ B 1-10V, Push

**Materials**

Shade: Aluminum. Diffuser: Polycarbonate.  
Structures: Steel. Canopy: Aluminum.

**Light Source and electronics**  
1 x LED PLATE 13,5 W 700 mA  
Constant Current 700 mA  
110-240V 50/60Hz

**Packaging**

1 Box 0,45 x 0,45 x 0,25 m  
Vol 0,0051 m<sup>3</sup>  
Gross weight 3,10 Kg Net weight 1,91 Kg

**Notes**

\* Electrical connection point

5922

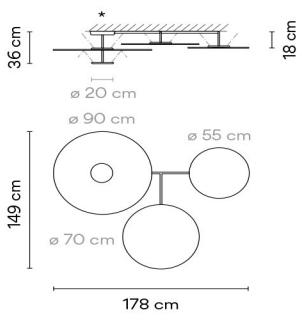

- Finishes**
- 10/ \_\_ White (NCS S 0300-N)
  - 71/ \_\_ White, Green L1, Grey L1 (NCS S 0300-N, NCS S 4005-G80Y, NCS S 1000-N)

- LED temperature colour**
- /1 \_ 2700 K CRI >90 13920 lm 139 lm/W
  - /3 \_ 3500 K CRI >90 14951,1 lm 149,5 lm/W

- Control**
- 5922 \_\_ / \_ A DALI-2, 1-10V, Push
  - 5922 \_\_ / \_ Z Casambi

**Materials**

Shade: Aluminum. Diffuser: Polycarbonate.  
Structures: Steel. Canopy: Aluminum.

**Light Source and electronics**  
4 x LED PLATE 25 W 700mA  
Constant Current 700 mA  
110-240V 50/60Hz

**Packaging**

1 Box 1,35 x 1,20 x 0,30 m  
Vol 0,0486 m<sup>3</sup>  
Gross weight 26,60 Kg Net weight 19,98 Kg

**Notes**

\* Electrical connection point

5924

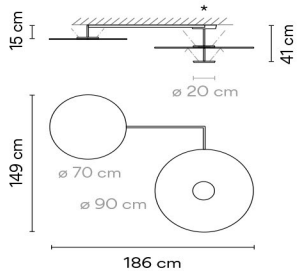

- Finishes**
- 10/ \_\_ White (NCS S 0300-N)
  - 72/ \_\_ White, Green L1 (NCS S 0300-N, NCS S 4005-G80Y)
  - 73/ \_\_ White, Grey L1 (S 0300-N, NCS S 1000-N)

- LED temperature colour**
- /1 \_ 2700 K CRI >90 9897,27 lm 132 lm/W
  - /3 \_ 3500 K CRI >90 10630,4 lm 141,7 lm/W

- Control**
- 5924 \_\_ / \_ A DALI-2, 1-10V, Push
  - 5924 \_\_ / \_ Z Casambi

**Materials**

Shade: Aluminum. Diffuser: Polycarbonate.  
Structures: Steel. Canopy: Aluminum.

**Light Source and electronics**  
3 x LED PLATE 25 W 700mA  
Constant Current 700 mA  
110-240V 50/60Hz

**Packaging**

1 Box 1,45 x 1,10 x 0,25 m  
Vol 0,0399 m<sup>3</sup>  
Gross weight 27 Kg Net weight 20,80 Kg

**Notes**

\* Electrical connection point

1160 | 10 | /1A  
 Model      Finish  
 LED temperature colour      Control

5926

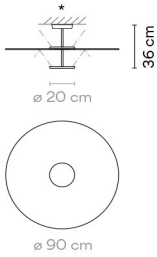

Finishes

● 10/ \_ \_ White  
 (NCS S 0300-N)

LED temperature colour

/1 \_ 2700 K **D**  
 CRI >90 6598,18 lm 132 lm/W  
 /3 \_ 3500 K **E**  
 CRI >90 7086,9 lm 141,7 lm/W

Control

5926 \_ \_ / \_ A  
 DALI-2, 1-10V, Push

Materials

Shade: Aluminum. Diffuser: Polycarbonate.  
 Structures: Steel. Canopy: Aluminum.

Light Source and electronics

2 x LED PLATE 25 W 700 mA  
 Constant Current 700 mA  
 110-240V 50/60Hz

Packaging

1 Box 1,05 x 1,05 x 0,25 m  
 Vol 0,0276 m<sup>3</sup>  
 Gross weight 14,60 Kg Net weight 10,08 Kg

Notes

\* Electrical connection point

LED IP20 CE Dimmer



Pendants

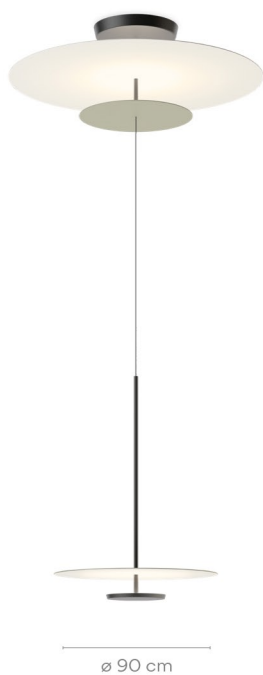

5930



5935



5940

5930

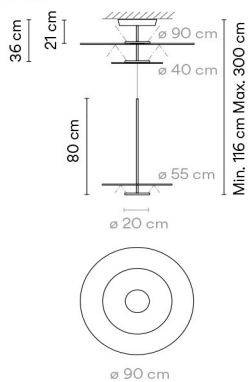

Finishes

- 13/ \_ \_ Off-White (NCS S 1000-N)
- 37/ \_ \_ Terra Red (NCS S 4040-Y70R)
- 47/ \_ \_ Green L1 (NCS S 4005-G80Y)

LED temperature colour

- /1 \_ 2700 K
- CRI >90 9897,27 lm 132 lm/W
- /3 \_ 3500 K
- CRI >90 10630,4 lm 141,7 lm/W

Control

- 5930 \_ \_ / \_ A DALI, 1-10V, Push
- 5930 \_ \_ / \_ Z Casambi

Materials

Shade: Aluminum Diffuser: Polycarbonate.  
Structures: Steel. Canopy: Aluminum

Light Source and electronics

3 x LED PLATE 25 W 700mA  
Constant Current 700 mA  
110~240V 50/60Hz

Packaging

1 Box 0,96x0,96x0,50 m  
Vol 0,4608 m<sup>3</sup>  
Gross weight 19 Kg Net weight 10,5 Kg

Notes

Adjust the height on installation



1160 10 / 1A \_ 18

Model  
 Finish  
 LED temperature colour  
 Control  
 Electrical connection  
 Only for pendants



5935

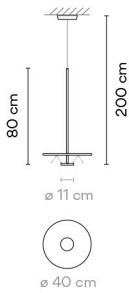

- |   |  |
|---|--|
| <b>Finishes</b>                         | <b>LED temperature colour</b>            |
| ● 13/ __ Off-White<br>(NCS S 1000-N)    | /1_ 2700 K  CRI >90 1740 lm 129 lm/W     |
| ● 37/ __ Terra Red<br>(NCS S 4040-Y70R) | /3_ 3500 K  CRI >90 1868,9 lm 138,4 lm/W |
| ● 47/ __ Green L1<br>(NCS S 4005-G80Y)  |  |

**Materials**

Shade: Aluminum Diffuser: Polycarbonate.  
 Structures: Steel. Canopy: Aluminum

**Light Source and electronics**

1 x LED PLATE 13,5 W 700 mA  
 Constant Current 700 mA  
 110-240V 50/60Hz

**Control**

5935 \_\_ / \_ 1  
 DALI  
 5935 \_\_ / \_ B  
 1-10V, Push

**Packaging**

1 Box 0,45 x 0,80 x 0,20 m  
 Vol 0,0072 m<sup>3</sup>  
 Gross weight 6,10 Kg Net weight 5 Kg

**Notes**

Extra cable length. 16,00 €/m

**Electrical connection**

- Surface
- \_18 Free Wire
- \_23 Built-in
- \_31 Remote
- Micro
- for plaster ceilings
- \_32 Remote
- XXS
- for all types of drop ceilings

5940

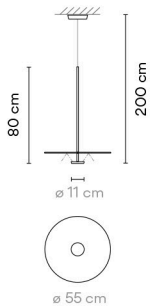

- |   |  |
|---|--|
| <b>Finishes</b>                         | <b>LED temperature colour</b>            |
| ● 13/ __ Off-White<br>(NCS S 1000-N)    | /1_ 2700 K  CRI >90 1740 lm 129 lm/W     |
| ● 37/ __ Terra Red<br>(NCS S 4040-Y70R) | /3_ 3500 K  CRI >90 1868,9 lm 138,4 lm/W |
| ● 47/ __ Green L1<br>(NCS S 4005-G80Y)  |  |

**Materials**

Shade: Aluminum Diffuser: Polycarbonate.  
 Structures: Steel. Canopy: Aluminum

**Light Source and electronics**

1 x LED PLATE 13,5 W 700 mA  
 Constant Current 700 mA  
 110-240V 50/60Hz

**Control**

5940 \_\_ / \_ 1  
 DALI  
 5940 \_\_ / \_ B  
 1-10V, Push

**Packaging**

1 Box 0,65 x 0,85 x 0,20 m  
 Vol 0,0111 m<sup>3</sup>  
 Gross weight 7 Kg Net weight 6 Kg

**Notes**

Extra cable length. 16,00 €/m

# Composing pendants

Next sketches are composed by one or more compositions

---

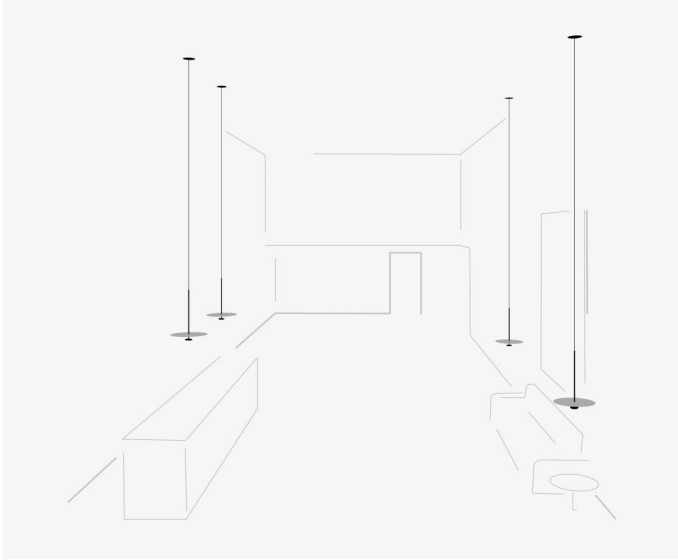

4 x 5935.

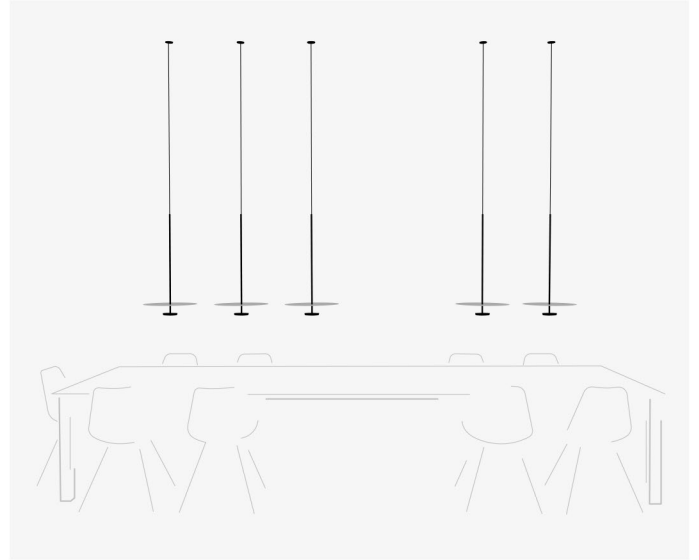

5 x 5935.

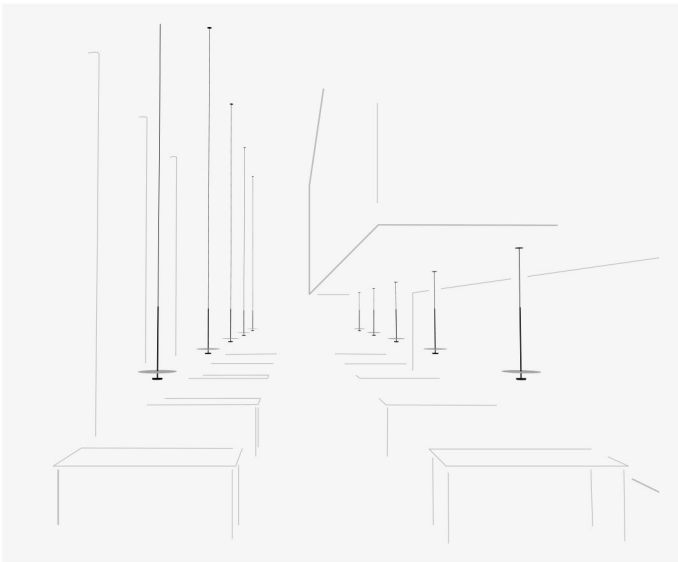

10 x 5935..

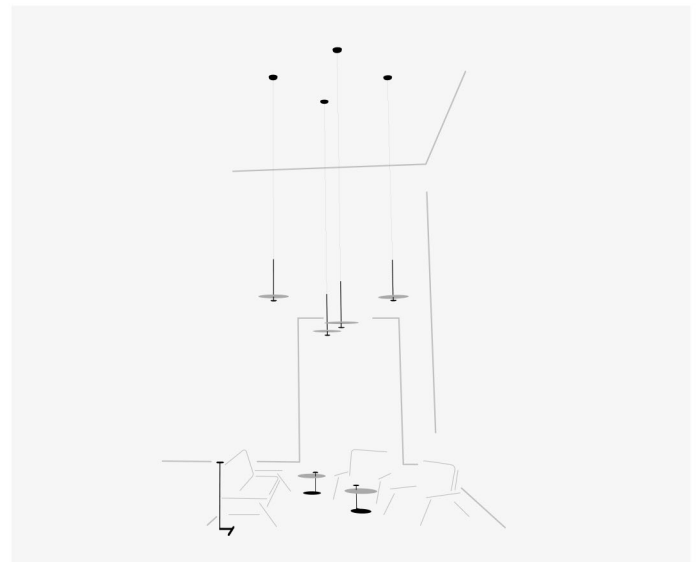

4 x 5935.

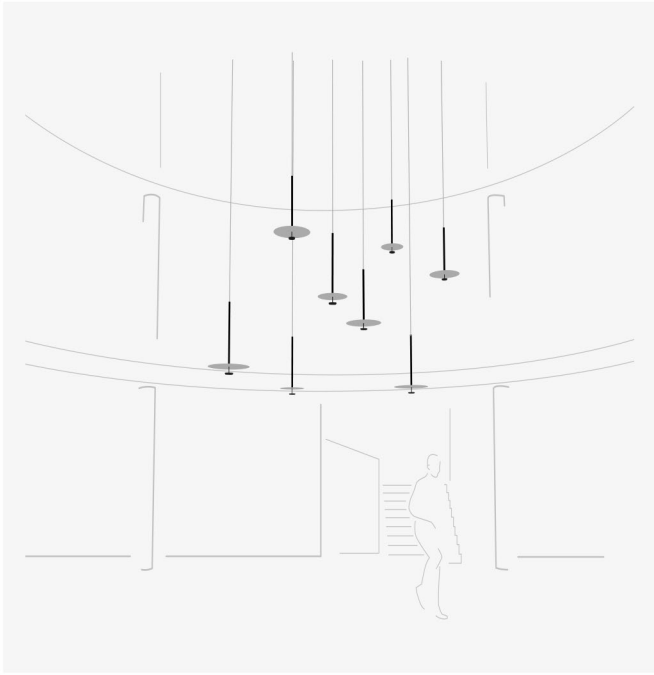

8 x 5935.

Each project is unique.  
Visit [vibia.com](http://vibia.com) and  
chose among multiple  
compositions designed  
and adapted to your  
project needs.

Personalise your own  
Flat composition quick  
and easy at [vibia.com](http://vibia.com)

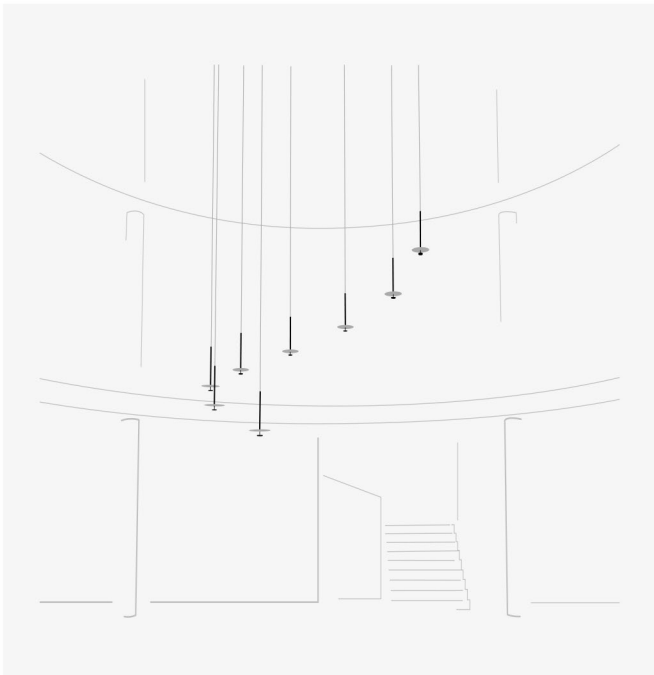

8 x 5935.



# Electrical connection options for model 5935

Choose your preferred installation option according to your needs. For each composition, the optimal minimum number of drivers will be delivered.

## Drop ceiling

The innovative remote and built-in fittings accentuate the silkiness and lightness of compositions on suspended ceilings, its great visual grandeur taking center stage.

For Ref. 5935

### Remote

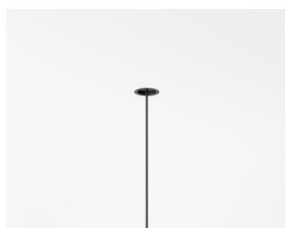

**Micro**  $\varnothing$  3 cm  
height 7 cm  
for plaster ceilings.  
Black finish.

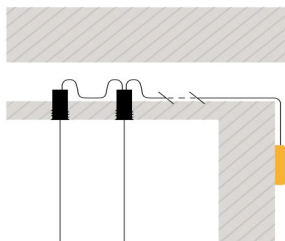

**XXS**  $\varnothing$  6 cm  
height 6 cm  
for all types of drop  
ceilings. Match with  
fixture finish.

### Built-in



$\varnothing$  8 cm  
height 6 cm  
match with  
fixture finish.

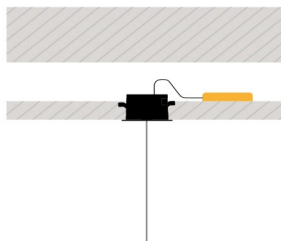

# Regular ceiling

When architecture does not allow for performance, surface and free wire showcase possibilities for any need or desire with no limits, ideal for both individual or cluster arrangements.

For Ref. 5935

## Surface



ø 16,7 cm

match with fixture finish.

## Free Wire

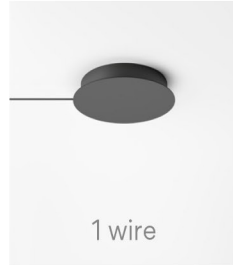

1 wire

ø 20 cm

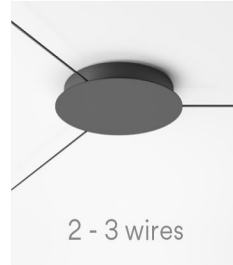

2 - 3 wires

ø 22 cm

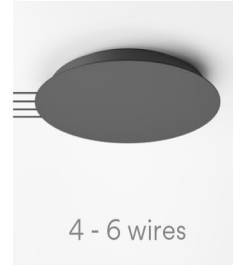

4 - 6 wires

ø 36 cm



7 - 9 wires

ø 40 cm

you can choose the finish of the canopy among black, white or any colour matching one of the pendants.

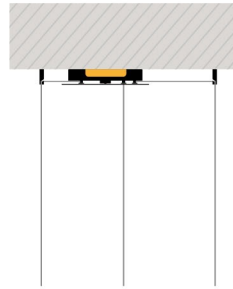
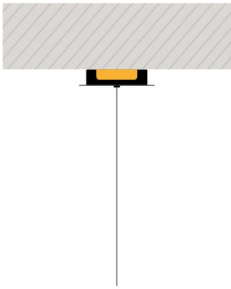

Floor



5945



5950

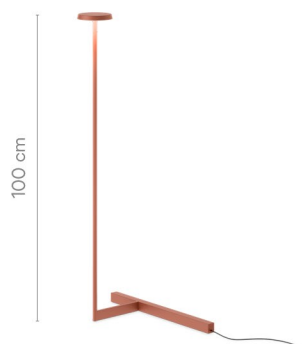

5955



5957

5945

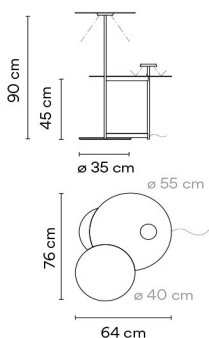

<b>Finishes</b>	<b>LED temperature colour</b>
● 13/ __ Off-White (NCS S 1000-N)	/1_ 2700 K  CRI >90 1365,8 lm 98 lm/W
● 47/ __ Green L1 (NCS S 4005-G80Y)	/3_ 3500 K  CRI >90 1467,0 lm 104,8 lm/W

**Control**  
5945 \_\_ / \_ 5  
Push

**Materials**  
Shade: Aluminum.  
Diffuser: Polycarbonate. Structures: Steel.

**Light Source and electronics**  
2 x LED PLATE 7 W 400 mA  
Driver Constant Voltage 24V  
110-240V 50/60Hz

**Packaging**  
1 Box 0,65 x 1,00 x 0,25 m  
Vol 0,0163 m<sup>3</sup>  
Gross weight 15,85 Kg Net weight 15,25 Kg

**Notes**  
Electric cable 2 m

5950

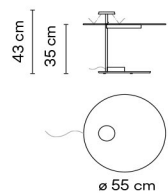

<b>Finishes</b>	<b>LED temperature colour</b>
● 10/ __ White (NCS S 0300-N)	/1_ 2700 K  CRI >90 682,9 lm 98 lm/W
	/3_ 3500 K  CRI >90 733,5 lm 104,8 lm/W

**Control**  
5950 \_\_ / \_ 5  
Push

**Materials**  
Shade: Aluminum.  
Diffuser: Polycarbonate. Structures: Steel.

**Light Source and electronics**  
1 x LED PLATE 7 W 400 mA  
Driver Constant Voltage 24V  
110-240V 50/60Hz

**Packaging**  
1 Box 0,65 x 0,65 x 0,20 m  
Vol 0,0085 m<sup>3</sup>  
Gross weight 14,60 Kg Net weight 12,71 Kg

**Notes**  
Electric cable 2 m



### 5955

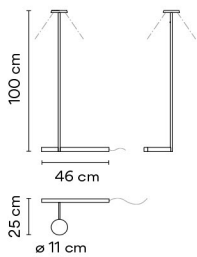

- Finishes**
- **11/** \_\_ Black (NCS S 8500-N)
  - **37/** \_\_ Terra Red (NCS S 4040-Y70R)
  - **47/** \_\_ Green L1 (NCS S 4005-G80Y)

- LED temperature colour**
- /1** \_ 2700 K CRI >90 682,9 lm 98 lm/W
  - /3** \_ 3500 K CRI >90 733,5 lm 104,8 lm/W

- Control**
- 5955** \_\_ / \_ 5  
 Push

**Materials**  
 Shade: Aluminum.  
 Diffuser: Polycarbonate. Structures: Steel.

**Light Source and electronics**  
 1 x LED PLATE 7 W 400 mA  
 Driver Constant Voltage 24V  
 110-240V 50/60Hz

**Packaging**  
 1 Box 0,30 x 1,10 x 0,10 m  
 Vol 0,0033 m<sup>3</sup>  
 Gross weight 4,80 Kg Net weight 3,50 Kg

**Notes**  
 Electric cable 2 m

### 5957

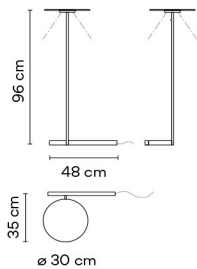

- Finishes**
- **37/** \_\_ Terra Red (NCS S 4040-Y70R)
  - **47/** \_\_ Green L1 (NCS S 4005-G80Y)

- LED temperature colour**
- /1** \_ 2700 K CRI >90 682,9 lm 98 lm/W
  - /3** \_ 3500 K CRI >90 733,5 lm 104,8 lm/W

- Control**
- 5957** \_\_ / \_ 5  
 Push

**Materials**  
 Shade: Aluminum.  
 Diffuser: Polycarbonate. Structures: Steel.

**Light Source and electronics**  
 1 x LED PLATE 7 W 400 mA  
 Constant Voltage 24V  
 110-240V 50/60Hz

**Packaging**  
 1 Box 0,40 x 1,10 x 0,10 m  
 Vol 0,0044 m<sup>3</sup>  
 Gross weight 6,10 Kg Net weight 4,46 Kg

**Notes**  
 Electric cable 2 m

Table



5965

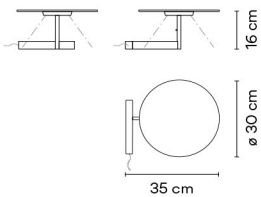

- Finishes**
- 13/ \_ \_ Off-White (NCS S 1000-N)
  - 47/ \_ \_ Green L1 (NCS S 4005-G80Y)

**LED temperature colour**  
/1\_ 2700 K   
CRI >90 682,9 lm 98 lm/W

**Control**  
5965 \_ \_ / \_ 5  
Push

**Materials**  
Shade: Aluminum.  
Diffuser: Polycarbonate. Structures: Steel.

**Light Source and electronics**  
1 x LED PLATE 7W 400mA  
Constant Voltage 24V  
110-240V 50/60Hz

**Packaging**  
1 Box 0,50 x 0,50 x 0,7 m  
Vol 0,0018 m<sup>3</sup>  
Gross weight 4 Kg Net weight 3,11 Kg

**Notes**  
Electric cable 2 m

5970

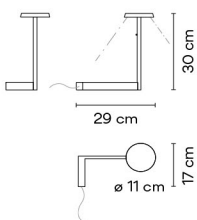

- Finishes**
- 11/ \_ \_ Black (NCS S 8500-N)
  - 37/ \_ \_ Terra Red (NCS S 4040-Y70R)
  - 47/ \_ \_ Green L1 (NCS S 4005-G80Y)

**LED temperature colour**  
/1\_ 2700 K   
CRI >90 682,9 lm 98 lm/W

**Control**  
5970 \_ \_ / \_ 5  
Push

**Materials**  
Shade: Aluminum.  
Diffuser: Polycarbonate. Structures: Steel.

**Light Source and electronics**  
1 x LED PLATE 7W 400mA  
Constant Voltage 24V  
110-240V 50/60Hz

**Packaging**  
1 Box 0,20 x 0,40 x 0,07 m  
Vol 0,0072 m<sup>3</sup>  
Gross weight 4 Kg Net weight 3,11 Kg

**Notes**  
Electric cable 2 m